

1.10mm Height 1210 Package
Bi-color (Multi-color) Chip LED
Technical Data Sheet

Part No: DL-PCB1210RGC

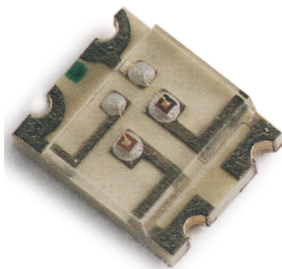

Double Light

◆ Features:

1. Package in 8mm tape on 7" diameter reel.
2. Compatible with automatic placement equipment.
3. Compatible with infrared and vapor phase reflow solder process.
4. Bi-color type.
5. Colors: Super Red & Yellow Green.
6. The product itself will remain within RoHS compliant Version.

◆ Descriptions:

1. The 1210 SMD LED is much smaller than lead frame type components, thus enable smaller board size, higher packing density, reduced storage space and finally smaller equipment to be obtained.
2. Besides, lightweight makes them ideal for miniature applications, etc.

◆ Applications:

1. Automotive: Backlighting in dashboard and switch.
2. Telecommunication: Indicator and backlighting in telephone and fax.
3. Flat backlight for LCD, switch and symbol.
4. General use.

Double Light

◆ Package Dimension:

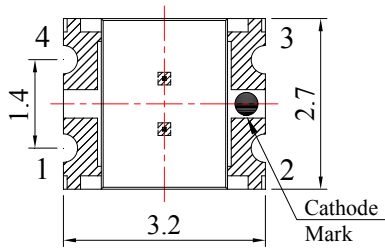

4 + ○ —▶ —○ - 3 GREEN

1 + ○ —▶ —○ - 2 RED

Polarity

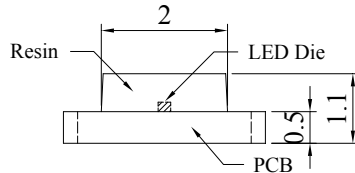

Recommended Soldering Pad Dimensions

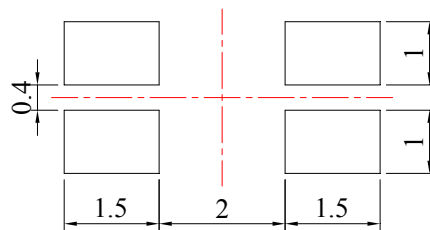
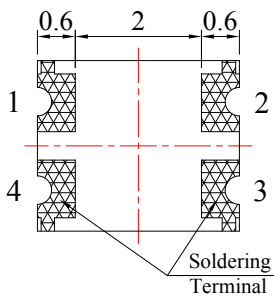

Unit: mm
Tolerance: $\pm 0.10\text{mm}$

Part No.	Chip Material		Lens Color	Source Color
DL-PCB1210RGC-1R-1G	S	GaAlAs	Water Clear	Super Red
	G	GaP		Yellow Green

Notes:

1. All dimensions are in millimeters (inches).
2. Tolerance is $\pm 0.10\text{mm}$ (.004") unless otherwise specified.
3. Specifications are subject to change without notice.

Double Light

◆ Absolute Maximum Ratings at Ta=25°C

Parameters	Symbol	Emitting Color	Max.	Unit
Power Dissipation	PD	Super Red	60	mW
		Yellow Green	72	
Peak Forward Current (1/10 Duty Cycle, 0.1ms Pulse Width)	IFP	Super Red	100	mA
		Yellow Green	100	
Continuous Forward Current	IF	Super Red	25	mA
		Yellow Green	30	
Reverse Voltage	VR	5		V
Electrostatic Discharge (HBM)	ESD	2000		V
Operating Temperature Range	Topr	-40°C to +80°C		
Storage Temperature Range	Tstg	-40°C to +85°C		
Soldering Temperature	Tsld	260°C for 5 Seconds		

Double Light

Electrical Optical Characteristics at Ta=25°C

Parameters	Symbol	Emitting Color	Min.	Typ.	Max.	Unit	Test Condition
Luminous Intensity	IV	Super Red	15	35	---	mcd	IF=20mA (Note 1)
		Yellow Green	16	30	---		
Viewing Angle	2 $\theta_{1/2}$	Super Red	---	120	---	Deg	IF=20mA (Note 2)
		Yellow Green	---	120	---		
Peak Emission Wavelength	λ_p	Super Red	---	660	---	nm	IF=20mA (Measurement @Peak)
		Yellow Green	---	575	---		
Dominant Wavelength	λ_d	Super Red	---	640	---	nm	IF=20mA (Note 3)
		Yellow Green	---	573	---		
Spectral Line Half-Width	$\Delta\lambda$	Super Red	---	45	---	nm	IF=20mA
		Yellow Green	---	30	---		
Forward Voltage	VF	Super Red	1.80	2.20	2.80	V	IF=20mA
		Yellow Green	1.80	2.20	2.80		
Reverse Current	IR	Super Red	---	---	10	μ A	V _R =5V
		Yellow Green					

Notes:

1. Luminous intensity is measured with a light sensor and filter combination that approximates the CIE eye-response curve.
2. $\theta_{1/2}$ is the off-axis angle at which the luminous intensity is half the axial luminous intensity.
3. The dominant wavelength (λ_d) is derived from the CIE chromaticity diagram and represents the single wavelength which defines the color of the device.

Double Light

◆ Typical Electrical / Optical Characteristics Curves

(25°C Ambient Temperature Unless Otherwise Noted)

Super Red:

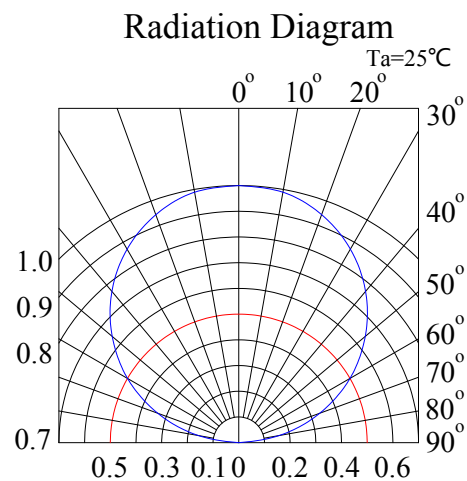
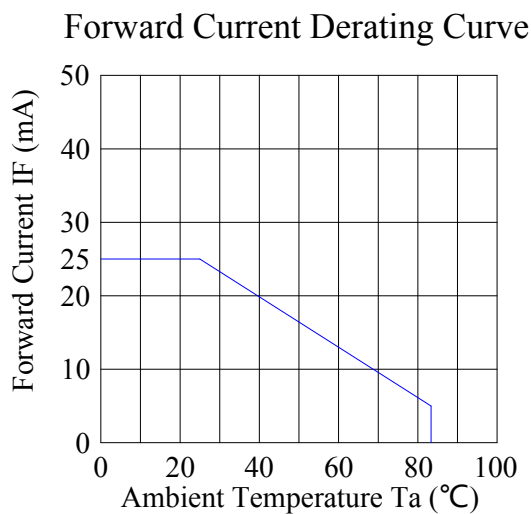
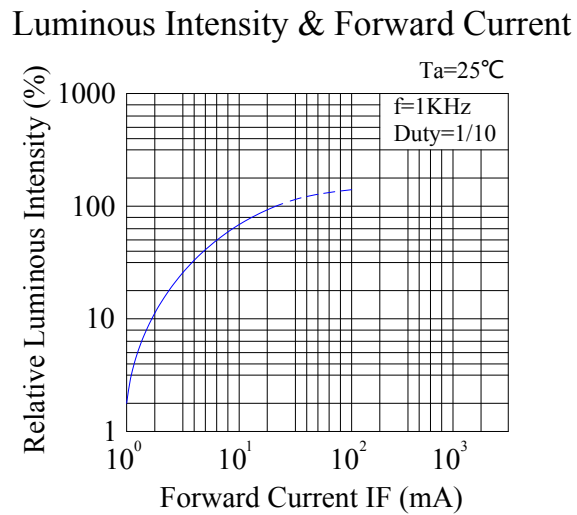
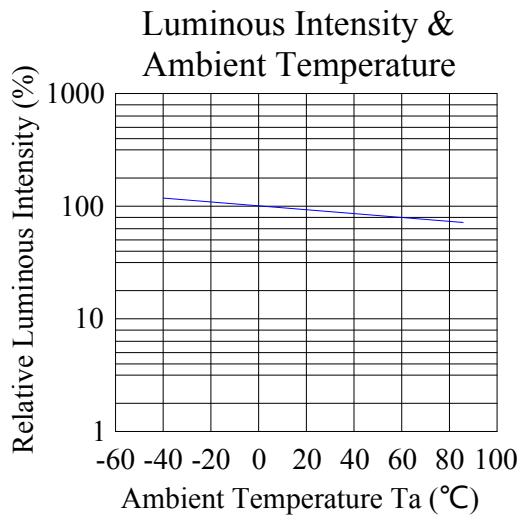
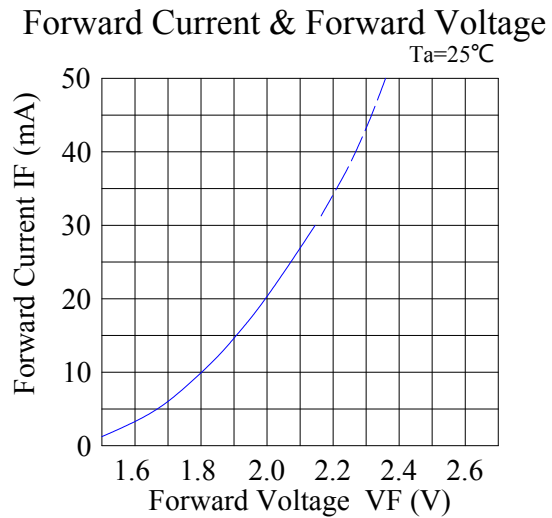
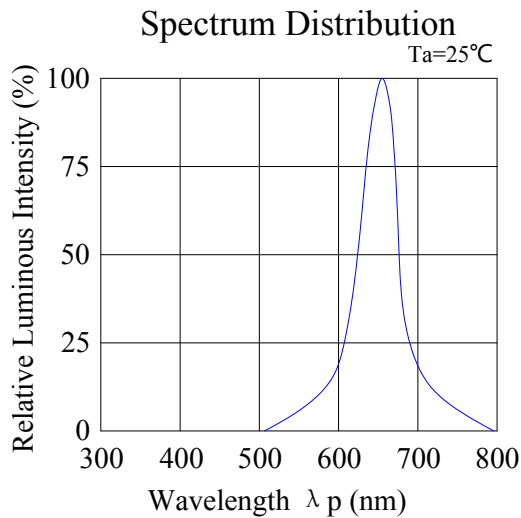

Double Light

Yellow Green:

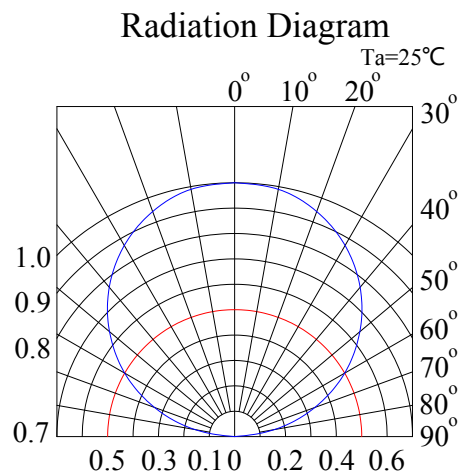
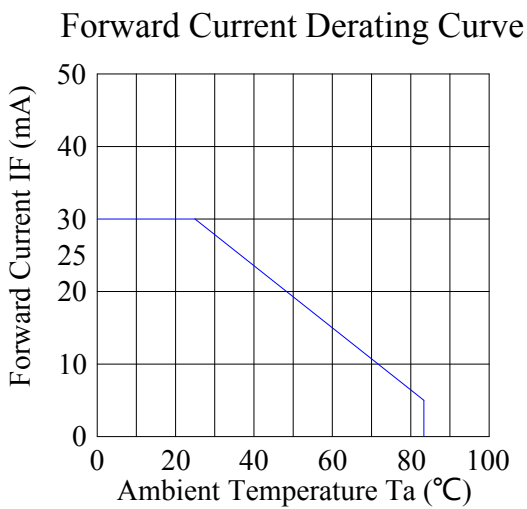
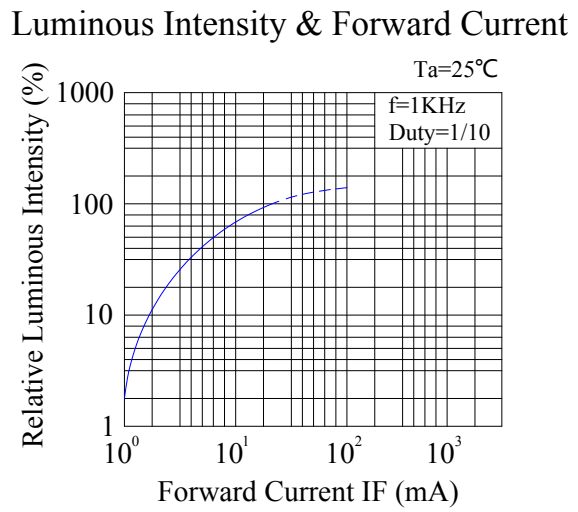
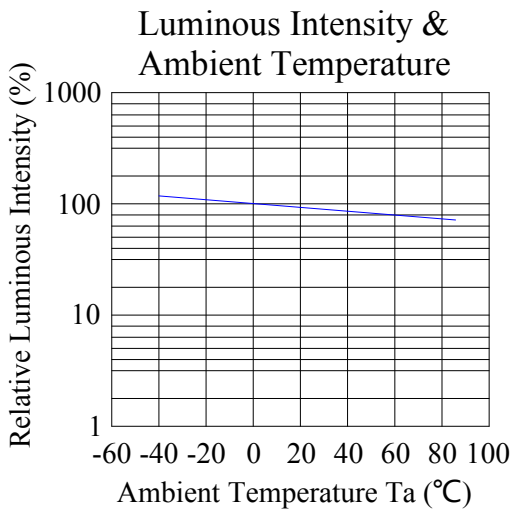
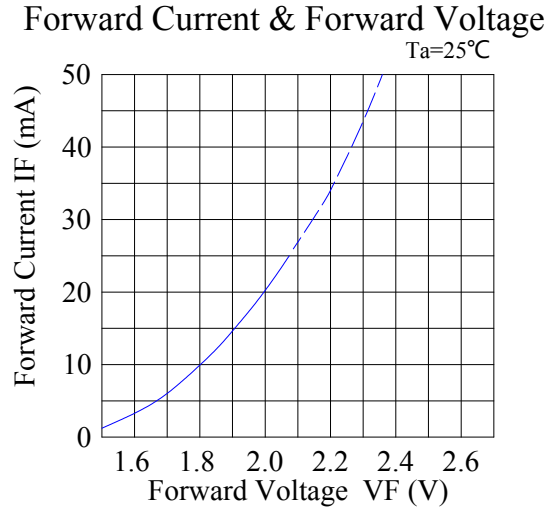
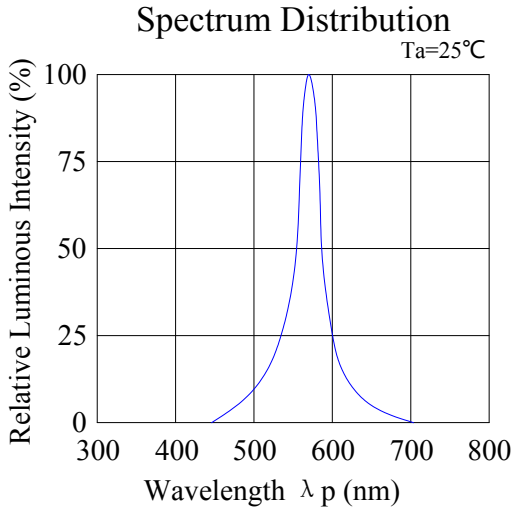

Double Light

◆ Reliability Test Items And Conditions:

The reliability of products shall be satisfied with items listed below:

Confidence level: 90%.

LTPD: 10%.

1) Test Items and Results:

No.	Test Item	Test Hours/Cycles	Test Conditions	Sample Size	Ac/Re
1	Resistance to Soldering Heat	6 Min	Tsld=260±5℃, Min. 5sec	25pcs	0/1
2	Thermal Shock	300 Cycles	H: +100℃ 5min j 10 sec L: -10℃ 5min	25pcs	0/1
3	Temperature Cycle	300 Cycles	H: +100℃ 15min j 5min L: -40℃ 15min	25pcs	0/1
4	High Temperature Storage	1000Hrs.	Temp: 100℃	25pcs	0/1
5	DC Operating Life	1000Hrs.	IF=20mA	25pcs	0/1
6	Low Temperature Storage	1000Hrs.	Temp: -40℃	25pcs	0/1
7	High Temperature/ High Humidity	1000Hrs.	85℃/85%RH	25pcs	0/1

2) Criteria for Judging the Damage:

Item	Symbol	Test Conditions	Criteria for Judgment	
			Min	Max
Forward Voltage	VF	IF=20mA	---	F.V.*)×1.1
Reverse Current	IR	VR=5V	---	F.V.*)×2.0
Luminous Intensity	IV	IF=20mA	F.V.*)×0.7	---

*) F.V.: First Value.

Double Light

◆ Reel Dimensions:

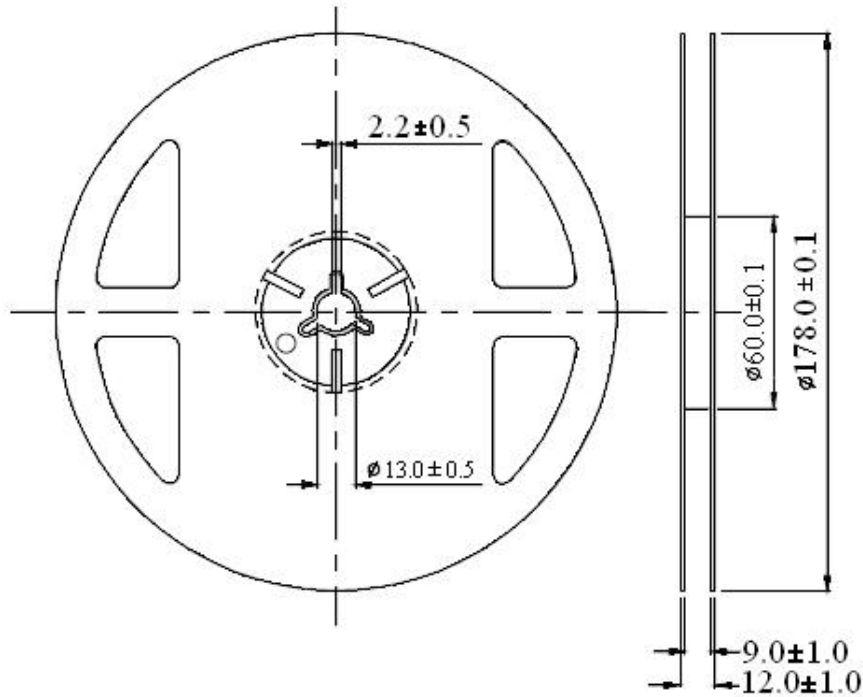

Unit: mm
Tolerance: ± 0.25 mm

Carrier Tape Dimensions:

Loaded quantity 2000PCS per reel.

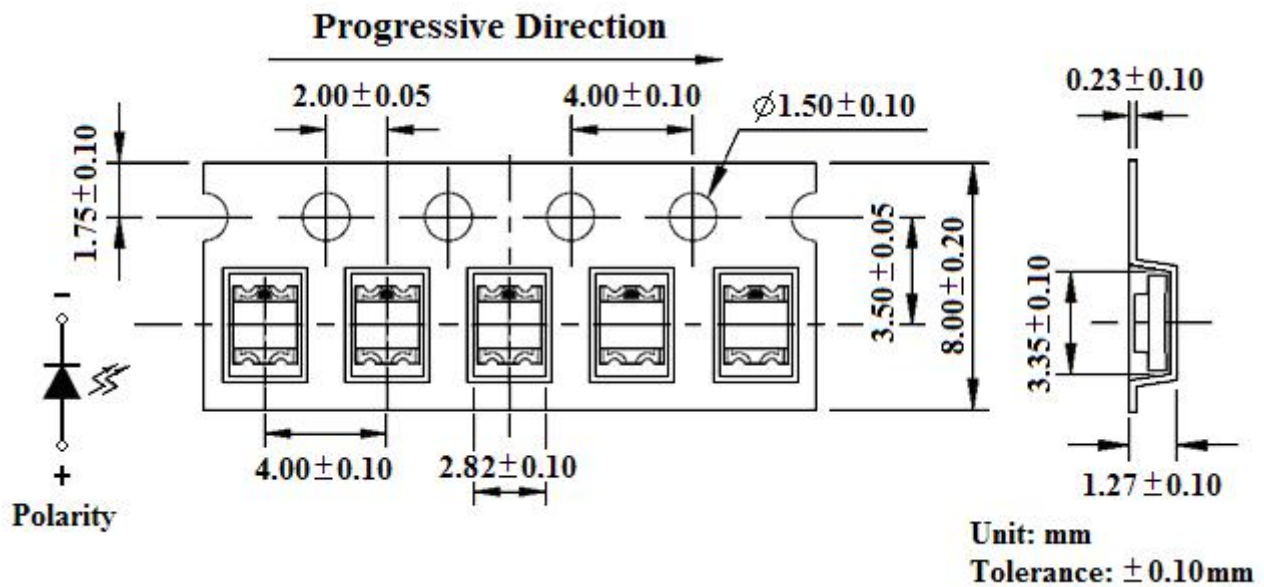

Unit: mm
Tolerance: ± 0.10 mm

Double Light

◆ Please read the following notes before using the product:

1. Over-current-proof

Customer must apply resistors for protection, otherwise slight voltage shift will cause big current change (Burn out will happen).

2. Storage

2.1 Do not open moisture proof bag before the products are ready to use.

2.2 Before opening the package, the LEDs should be kept at 30°C or less and 90%RH or less.

2.3 The LEDs should be used within a year.

2.4 After opening the package, the LEDs should be kept at 30°C or less and 70%RH or less.

2.5 The LEDs should be used within 168 hours (7 days) after opening the package.

2.6 If the moisture adsorbent material (silica gel) has fabled away or the LEDs have exceeded the storage time, baking treatment should be performed using the following conditions. Baking treatment: 60±5°C for 24 hours.

3. Soldering Condition

3.1 Pb-free solder temperature profile.

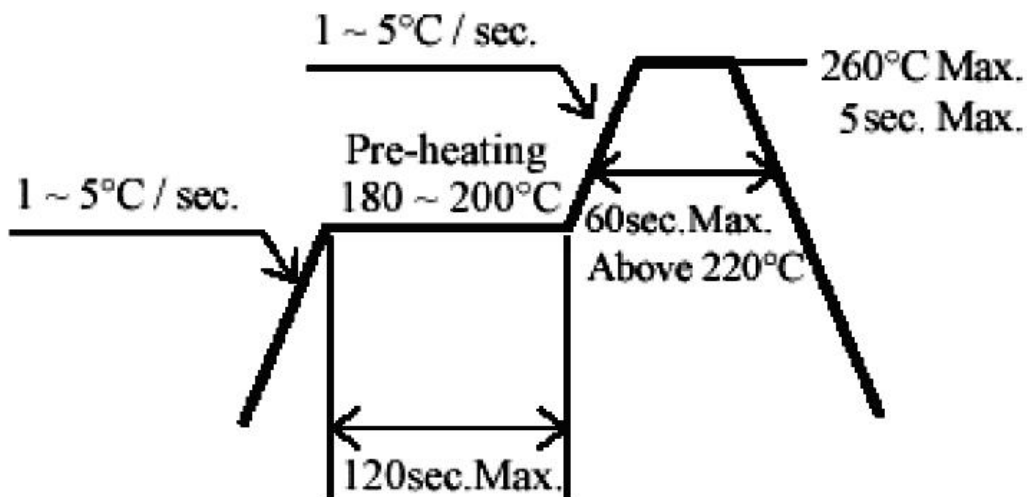

3.2 Reflow soldering should not be done more than two times.

3.3 When soldering, do not put stress on the LEDs during heating.

3.4 After soldering, do not warp the circuit board.

4. Soldering Iron

Each terminal is to go to the tip of soldering iron temperature less than 260°C for 5 seconds within once in less than the soldering iron capacity 25W. Leave two seconds and more intervals, and do soldering of each terminal. Be careful because the damage of the product is often started at the time of the hand solder.

5. Repairing

Repair should not be done after the LEDs have been soldered. When repairing is unavoidable, a double-head soldering iron should be used (as below figure). It should be confirmed beforehand whether the characteristics of the LEDs will or will not be damaged by repairing.

Double Light

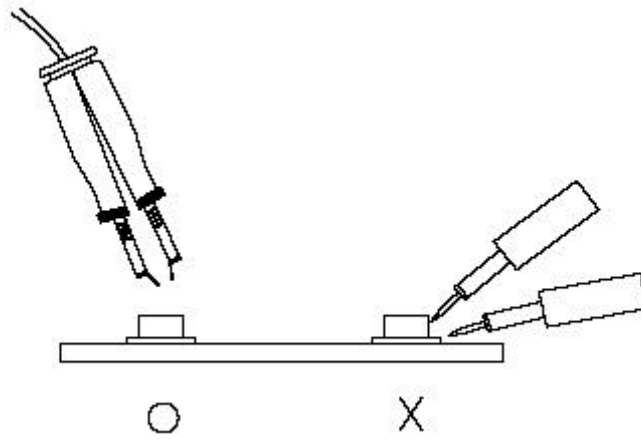

6. Caution in ESD

Static Electricity and surge damages the LED. It is recommended to use a wrist band or anti-electrostatic glove when handling the LED. All devices, equipment and machinery must be properly grounded.